

mixel *agitators*



●●● The art of mixing



Stirring markets

Mixel's mixing and stirring expertise is vital to many processes all over the world. From France, origin of our high-tech know-how, we stir international markets via our subsidiaries and the unique way in which we work closely with our customers.



The right answer



Attentive to the needs of our markets, conscious of the economic stakes of investments in production, Mixel meets manufacturers' expectations with relevant and tested technical solutions.

An international presence

Mixel's growth is due to our ability to act global and think local, the 24h support we provide and the fact that our clients know they can rely on our advice. Our **Chinese subsidiary** works with many manufacturing units in Asia. Our **Brazilian subsidiary** boosts our development in South America. Both contribute to our controlled growth by maintaining **our constant leadership in the sector**, in complete independence.



42,000 AGITATORS
AT WORK FOR
THOUSANDS
OF CUSTOMERS

REFERENCES

ARKEMA, BASF, BAYER, CARGILL,
CHEVRON ORONITE, DANONE, GIVAUDAN,
GLAXOSMITHKLINE, KRONENBOURG, MANE,
MARS CHOCOLAT, NIVÉA BEIERSDORF,
SANOFI, SHELL, SOLVAY, SUEZ VINCI,
SYNGENTA, TECHNIP, VEOLIA, VÉTOQUINOL...

water
treatment





ENGINEERING
DESIGN
MANUFACTURING

SPECIFIC
MACHINES

REVOLVING
MACHINES



EXPERTISE AS A BENCHMARK

Specific expertise for each market

Perfectly mixed products are essential for many pharmaceutical, chemical, water treatment, bio-industry, agribusiness, paint, paper making, cosmetics, and petrochemical companies.

Agitation is a strategic link in the «Product Excellence» chain.

A well-defined structure

Founded in 1969, Mixel gradually developed sales throughout many industries and is now a major player in international investment projects. **The presence of Mixel in world-scale production units** is a clear indicator of our ambitions. Our organization and resources show our company's strategic vision.

chemistry



An emulsion of creativity

Mixture implies diversity... and mixing magic is implicit in every agitation solution.



THINKING BEFORE MIXING

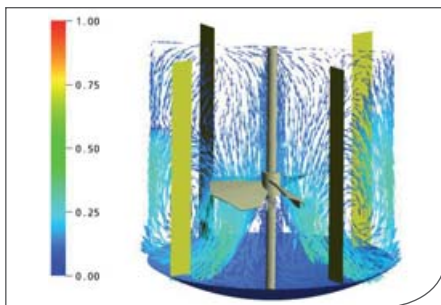

Controlled complexity

Adding liquids in industrial processes involves highly complicated engineering.

The control of flows, temperatures, physical behaviour, chemical reactions, density, viscosity, concentration, granulometry, the sedimentation rates of the products present are all

parameters Mixel has to consider when defining solutions. **Control based on expertise – and experience.**

A multidisciplinary team

Mixel has many and complementary skills. A technical-commercial team, a research and development service, a design engineering department, a purchasing department, a production workshop, on site service and maintenance technicians... **Mixel experts join forces to supply material in technical and economic adequation with each project.**

A team operating under an ISO 9001:2008 quality management system is dedicated to each project from the initial design phase through to the production of the equipment supplied.

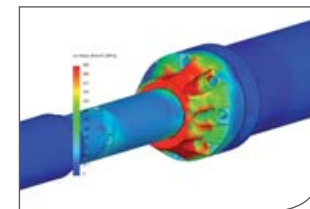
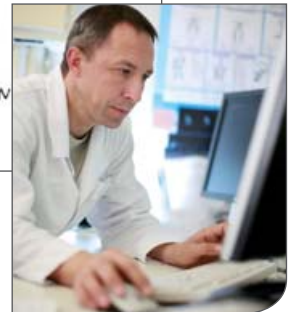
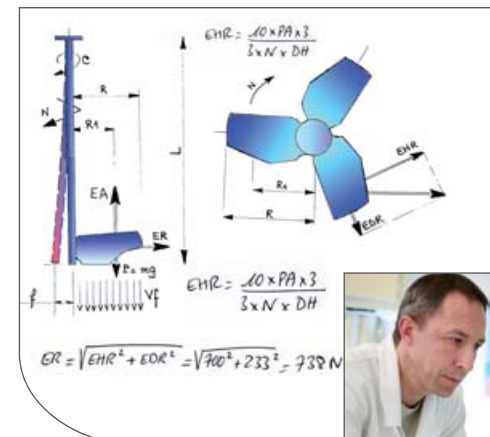

Specifications/ Project analysis
with the customer
(technical-commercial expertise)

Hydraulic and
mechanical study

Design/
Design solution

Manufacture
in our workshops

Installation and
commissioning of the
equipment on site



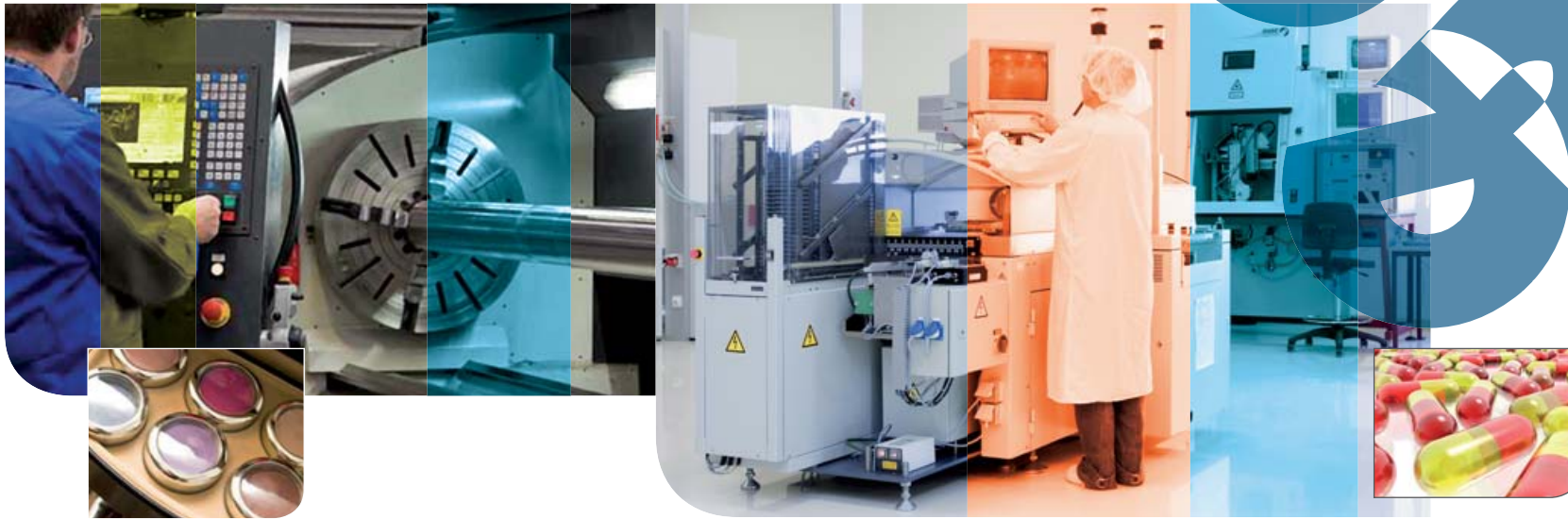

Assistance with decision-making

Due to our extensive field experience and technical expertise, our commercial team can assist every kind of manufacturer to define the most viable proposal **from the outset of the initial project concept phase.**

An operational and reactive participant

To progress as new technologies become available and as markets continuously evolve Mixel proposes **standard and tailor-made solutions....**



CREATIVITY - OUR DRIVING FORCE

Continuous awareness

Invent, research, discover, test...

Mixel works with manufacturers on a daily basis to define new solutions, new machines and new products - and to improve existing equipment.

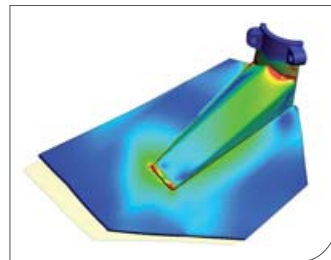

Prouven reliability

Our technological resources guarantee the reliability of all the equipment built, installed and maintained by Mixel.

Data collected before an agitator is produced include calculations by finite elements, forces, resistance and strength.



cosmetics

High-Productivity solutions

UNIQUE EXPERTISE,
A WIDE OFFER

Industrial productivity depends on the technology of the production equipment in place and its evolution and adaptation.



On site service expertise

Mixel's know-how is focused on tailor-made machines but we also **make our technology available for our «standard» range**. A major factor in Mixel's success is the on site services we provide including assembly and commissioning tests by our expert teams.



TAILOR-MADE
AGITATORS

STANDARD
AGITATORS

ON SITE
ASSEMBLY
SERVICES





petrochemistry

FROM STANDARD TO TAILOR-MADE

Ad hoc solutions

Whatever a customer's request, simple or complex, Mixel solutions are always an erudite combination of the following factors:



The position of the agitator depends on the function required



At the bottom of the tank

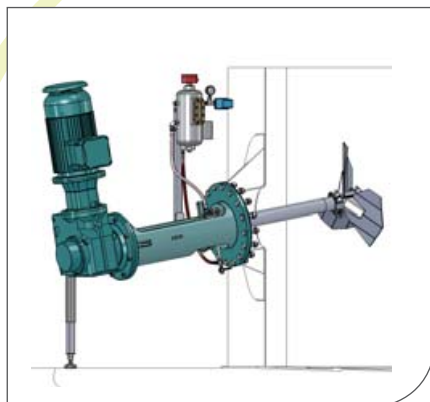

Side

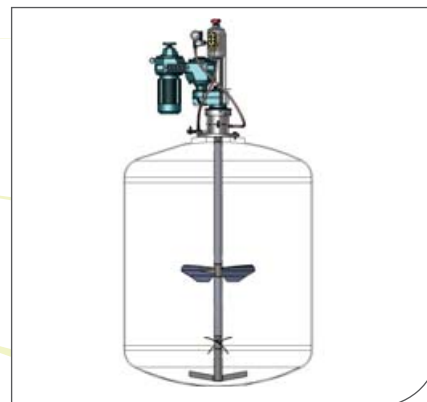

Vertical

MIXING

HOMOGENIZATION

EMULSION

DISSOLUTION

DISPERSION

Agitation impellers

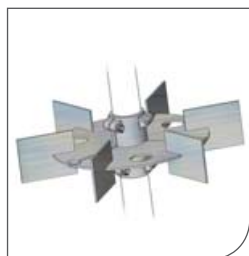

Rushton turbine

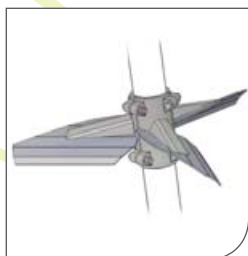

TTF propeller

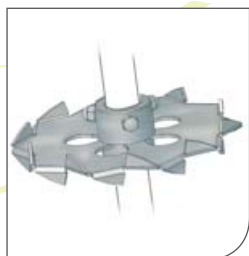

Dispersion turbine

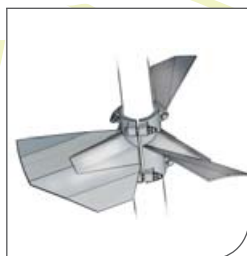

TT propeller

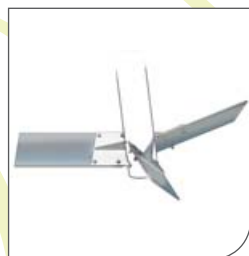

3 x 45° blade turbine



Anchor with scrapers

Standard agitators



Agimag Agitator



Agipro Agitator

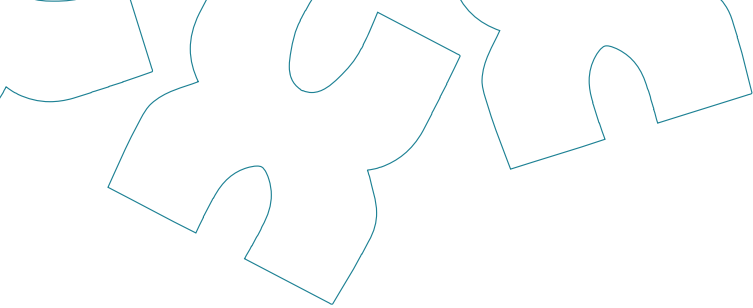
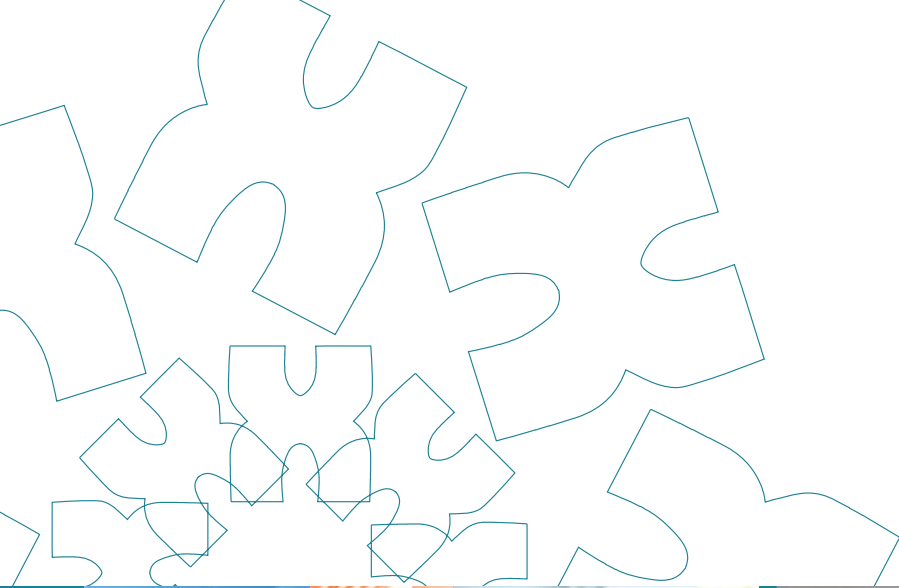

mixel
agitators

• • • **Mixel Agitators**
69 Dardilly - **France**
Phone: +33 (0)4 72 52 18 18
contact@mixel.fr - www.mixel.fr

• • • **Mixel Agitators**
Beijing - **PR China**
Phone: +86 10 67 89 22 85
contactch@mixel.fr - www.mixel.fr

• • • **Mixel Agitadores e Equipamentos Industriais**
Rio de Janeiro - **Brasil**
Phone: +55 21 2260 34 68
contatos@mixel.com.br - www.mixel.fr

