

Rev	Note	CreatedBy	Appr.By	Appr.Date
A	Initial release	AE	PW	2019-03-04

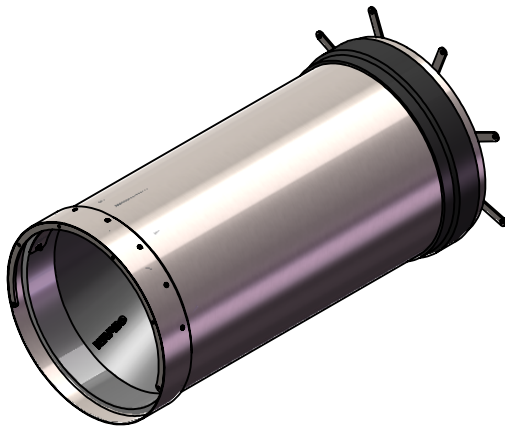

DETAIL B  
SCALE 1 : 5

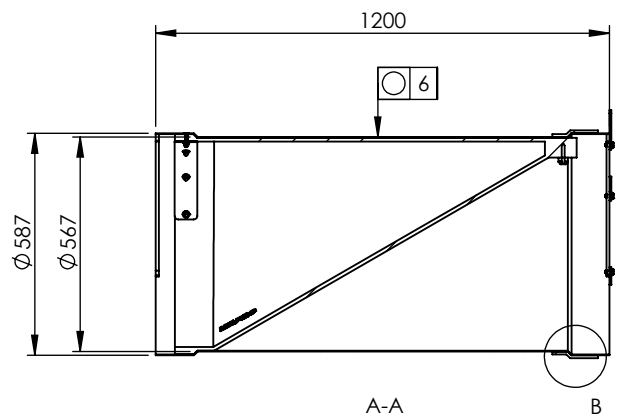
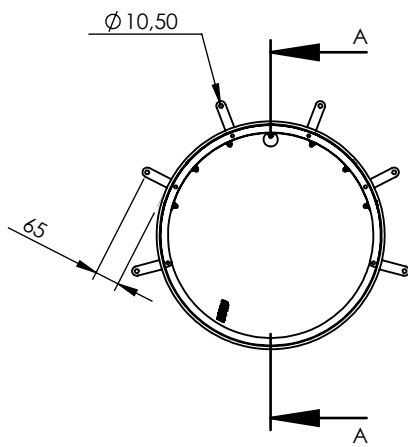
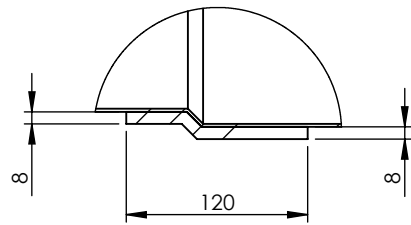

© 2018 Wapro AB. This document is subject to copyrights owned by Wapro AB. Any amendments, republication, retransmission, and/or reproduction of all or any part of the document is expressly prohibited, unless the copyright owner of the material has expressly granted its prior written consent. All other rights are reserved.

Designed By HE	Approved By	Created Date 2019-12-16	Units [mm]	General Tolerance ISO 13920A	Scale 1:20	
Material EN 1.4301 / EN 1.4404	Comments		Project			
Weight [kg] 52,26	Box Volume [m³] 0,42	Description WaStop DN600				
 www.wapro.com		Reversed				
		Article Number WS590-S-REVERSED	Drawing Number ws590-s-reversed-en	Rev A	Sheet 1 (1)	