

Rev	Note	CreatedBy	Appr.By	Appr.Date
A	Initial release		AE	2019-05-23

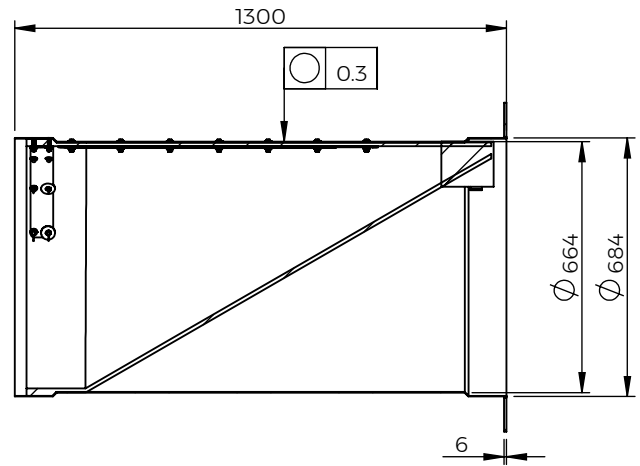

A-A

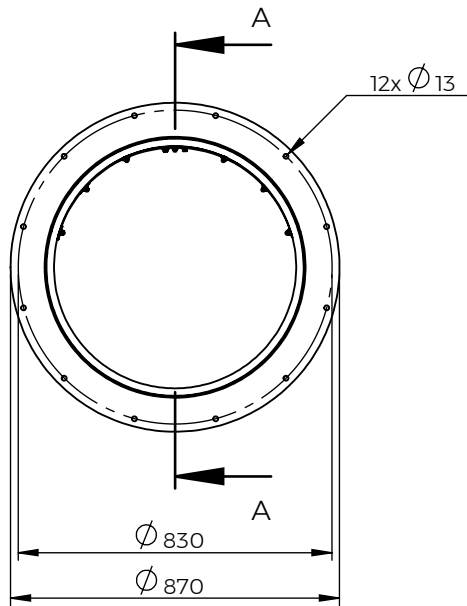
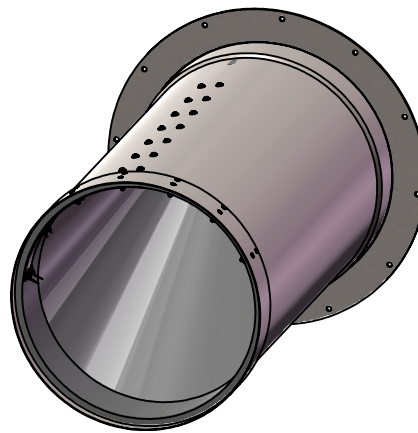

© 2018 Wapro AB. This document is subject to copyrights owned by Wapro AB. Any amendments, republication, retransmission, and/or reproduction of all or any part of the document is expressly prohibited, unless the copyright owner of the material has expressly granted its prior written consent. All other rights are reserved.

Designed By PM	Approved By PM	Created Date 2012-05-11	Units [mm]	General Tolerance ISO 13920A	Scale 1:20	
Material EN 1.4301 / EN 1.4404			Comments		Project	
Weight [kg] 75.80	Box Volume [m³]		Description WaStop DN700			
 www.wapro.com			Flange Inlet			
			Article Number WS690-S-FL2	Drawing Number ws690-s-fl2-en	Rev A	Sheet 1 (1)